

Key Stage 2

Glow Week

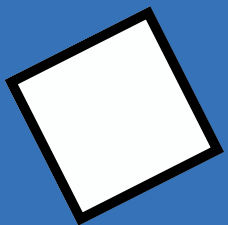

Put the below pictures into the right order for safely crossing the road

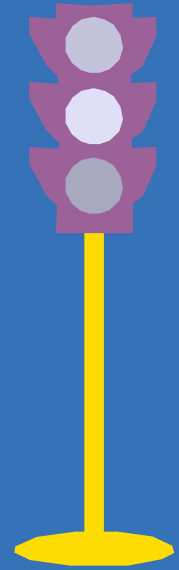
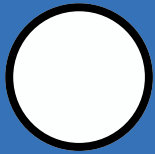
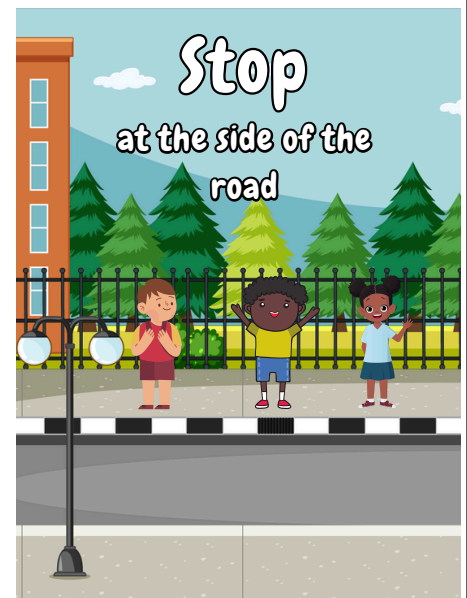

Can you find all eight words
below:



S A B M E R T I L O O K
H I R P N E B R I G H T
S E I F E F I G B O L T
H A L N T L D O R F I L
Y M L M G E C F A R S U
D S I U E C U S I P T I
R T A G U T W I N F E N
A R N S S I N G K F N U
T R T R E V T N A A E R
E A R M L E C S T N I Y
D G R E E N M A N E S N
S E N S I B L E O Y E T

BRAIN

BRIGHT

BRILLIANT

GREEN MAN

HELMET

HYDRATE

INJURY

LISTEN

LOOK

REFLECTIVE

SAFE

SENSIBLE

If you would like to donate any money towards Child Brain Injury Trust and help children who have acquired a brain injury, please ask a grown up to scan this QR code:



Can you fill in the sentences below from the words below?

cross helmet behind seen
concentrate travelling bright tracks
exit quiet stop, look, listen, think

1. It is important to always wear a seatbelt when in a car.
2. The driver needs to on the road. Stay in the car and do not distract the driver.
3. Always wear a when riding a bike or scooter.
4. Be careful walking cars in a car park. They may be reversing and not see you.
5. Always the road at a pedestrian crossing.
6. Use when crossing the road.
7. Always the car on the pathway side
8. Never walk or play on train
9. Always make sure you are wearing clothes to be and

Multiplication Mosaic

Solve the maths problems to reveal a hidden picture. Each answer has a special colour.

Blue: 12, 20, 30, 14, 4, 10

Yellow: 8, 50, 22, 24, 40, 55

Grey: 15, 25, 100

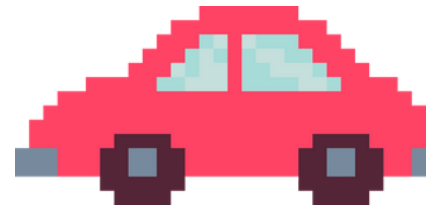

2×6	10×2	5×6	2×7	5×4	5×6	2×6	2×2	2×5	10×1	10×3
10×3	2×2	2×5	10×1	2×2	2×7	10×1	2×5	10×2	2×7	2×6
10×2	2×6	5×4	2×4	2×12	2×5	5×10	11×2	5×4	2×2	10×3
2×2	5×2	10×1	11×2	10×4	5×10	5×8	11×5	2×7	5×4	10×2
2×7	2×2	10×3	5×10	2×12	5×10	2×12	5×10	10×2	2×7	2×2
10×1	5×4	2×12	11×2	2×4	5×8	11×5	5×8	2×4	5×6	10×1
5×4	2×5	5×5	5×3	5×5	10×10	5×5	10×10	5×5	2×2	2×6
10×3	2×7	5×8	2×12	10×4	5×10	2×12	2×4	5×8	2×6	5×4
5×2	2×2	10×10	5×3	5×5	5×3	10×10	5×5	5×3	10×1	2×7
2×7	10×1	2×4	5×8	11×2	10×2	10×4	5×10	2×4	2×7	2×2
10×2	5×2	10×3	2×6	10×1	2×2	10×3	2×7	10×1	2×6	2×7

True or false?

44% of cycling casualties occur at times when children are travelling to and from school.

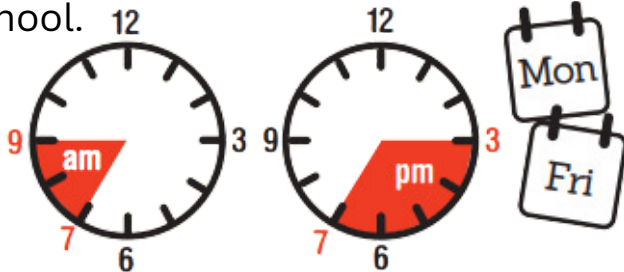

True False

In 2022, 33% of trips to and from school were made by walking, by children aged 5 to 10.

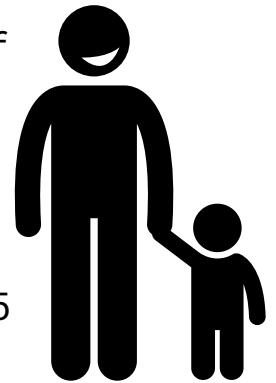

True False

Wearing a helmet can reduce the risk of serious head or brain injury by 69%.



True False

You can stop using a booster seat when you think you are tall enough.

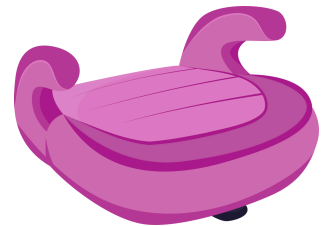

True False



It is better to run across the road, so you cross faster.

True False



Black and blue are the easiest colours to see in the dark.

True False



You only need to wear a helmet when you're riding a bike not a scooter.

True False

Help Ivy cycle home, by finding the route with the correct answers.

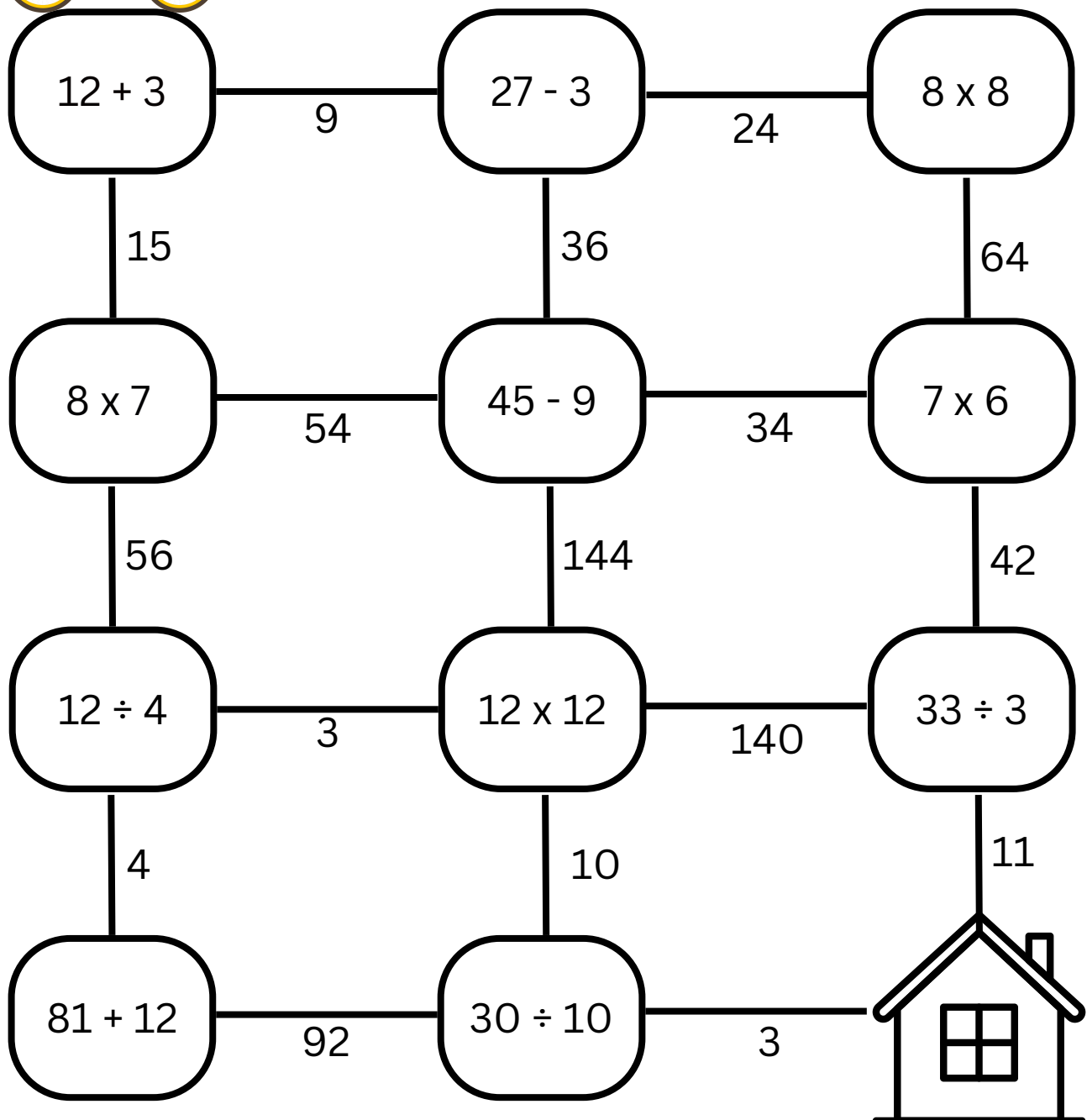

Name:

Age:

Road Safety Competition



Design and colour a Hi Vis jacket and helmet below:

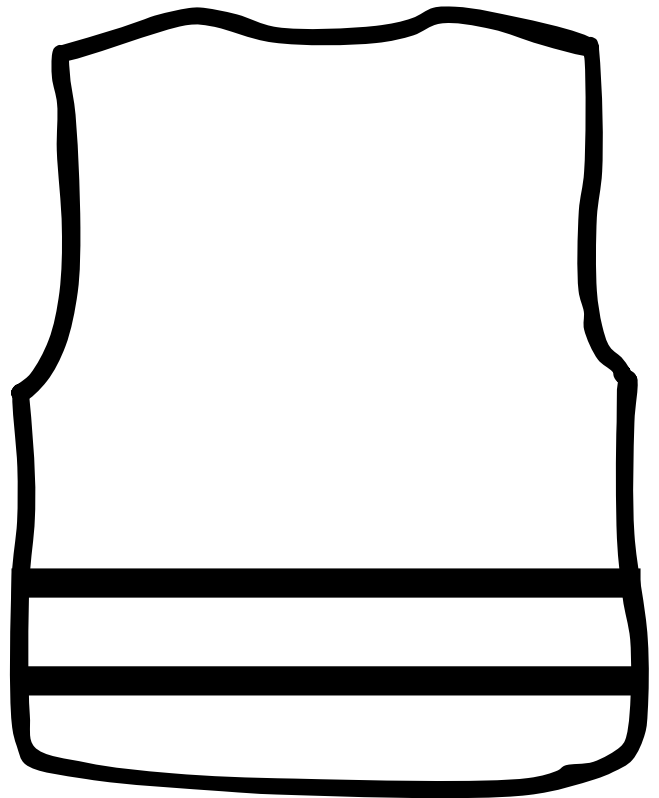
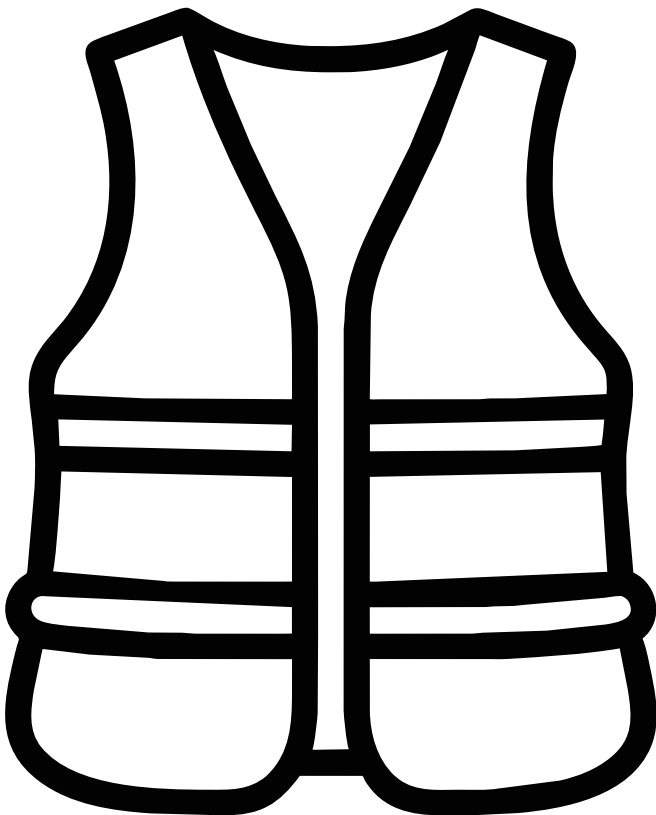

To submit please email fundraising@cbituk.org or tag us on social media @CBITUK